

SIDES	BOTTOM
Material:Steel-(C1008-1018) Zinc Plated	

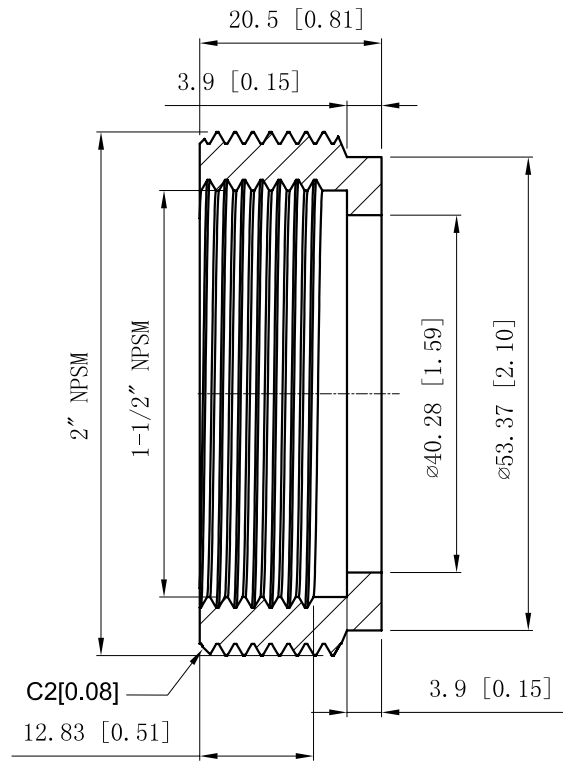

VIEW A-A

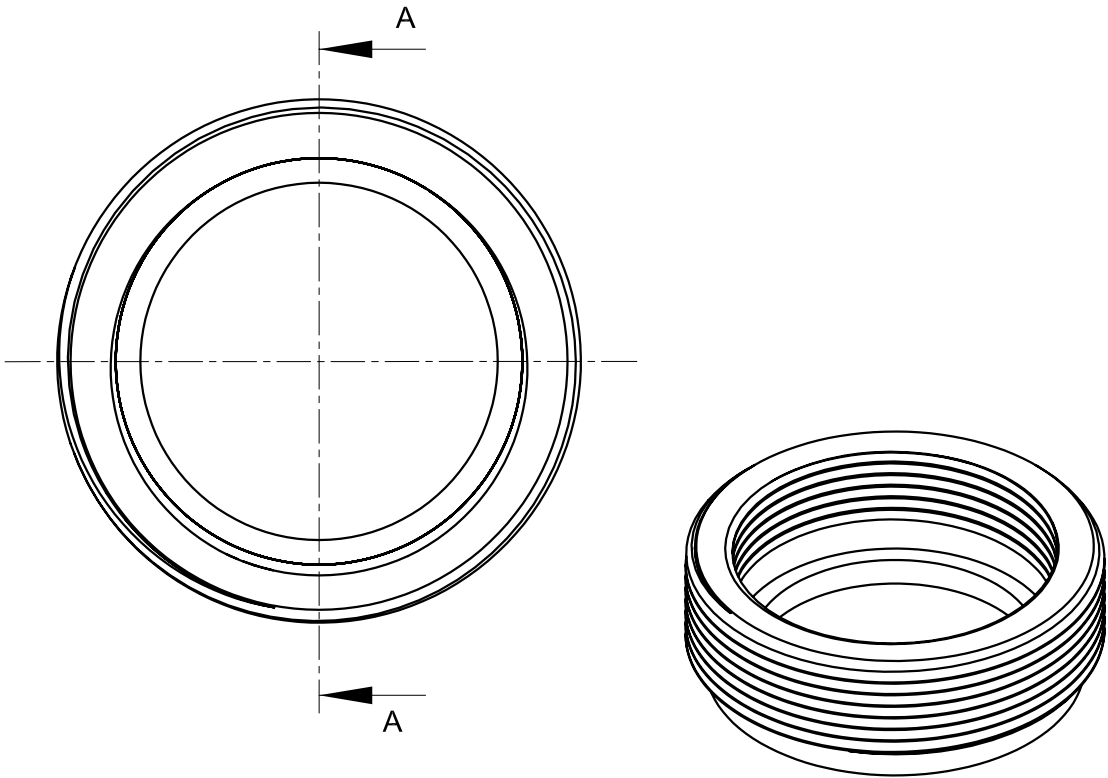

DESCRIPTION
TRADE REFERENCE TERMS

This data sheet is for reference only .GARVIN INDUSTRIES reserves the right to make changes to the design without prior notice.

STANDARD PACKING	<h1 style="text-align: center;">GARVIN INDUSTRIES</h1> <h2 style="text-align: center;">STEEL REDUCING BUSHING</h2>		
10 PCS			
	TITLE		
	SIZE	DWG NO.	REV
	A4	RB200150	
	DATA SHEET		