

SIDES	BOTTOM
Material:Steel-(C1008-1018) Zinc Plated	

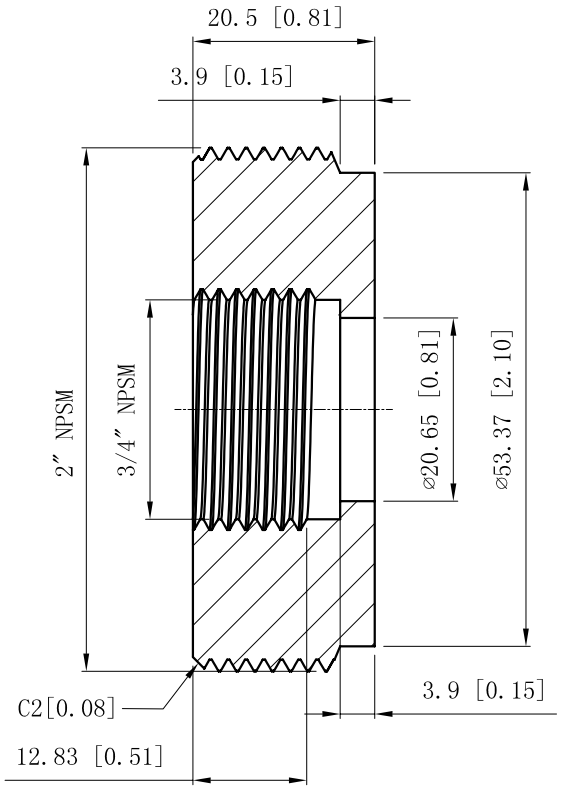

VIEW A-A

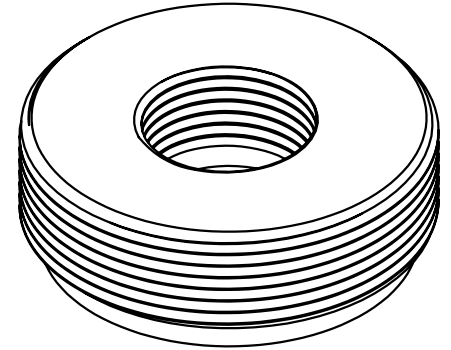
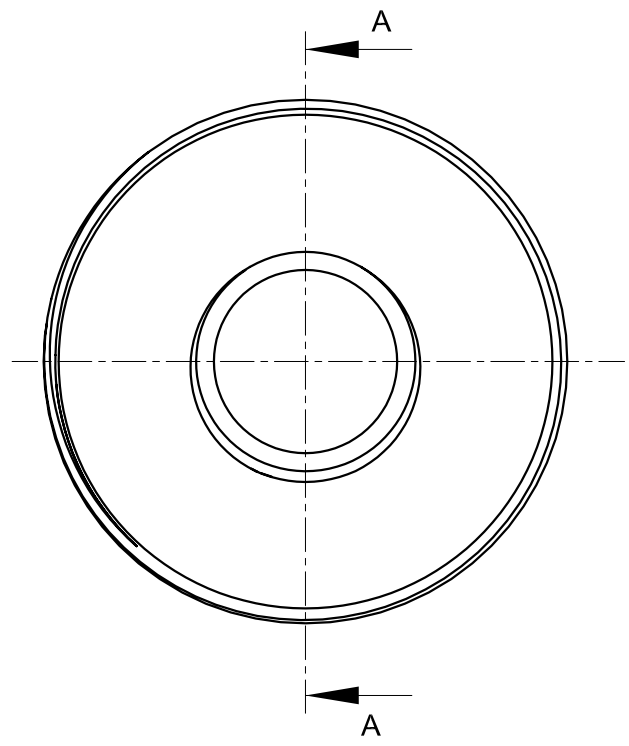

DESCRIPTION
TRADE REFERENCE TERMS

This data sheet is for reference only .GARVIN INDUSTRIES reserves the right to make changes to the design without prior notice.

STANDARD PACKING	<h1 style="text-align: center;">GARVIN INDUSTRIES</h1> <h2 style="text-align: center;">STEEL REDUCING BUSHING</h2>		
10 PCS			
SIZE	DWG NO.	REV	
A4	RB20075		
DATA SHEET			