

SIDES	BOTTOM
Material:Steel-C1008~C1018, zinc plated	

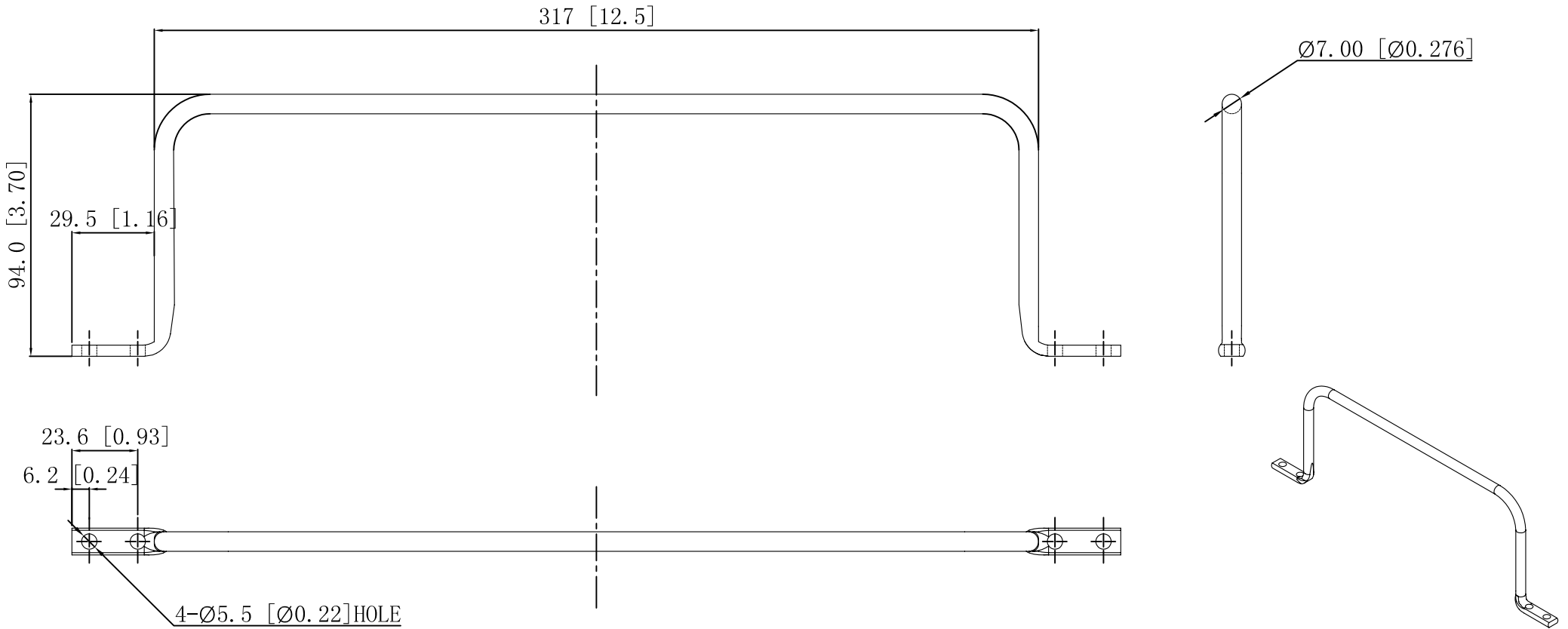

This data sheet is for reference only .GARVIN INDUSTRIES reserves the right to make changes to the design without prior notice.

DESCRIPTION
TRADE REFERENCE TERMS

STANDARD PACKING
25 Pcs

GARVIN INDUSTRIES		
TITLE DISTRIBUTION RINGS		
SIZE A4	DWG NO. DST-1200	REV
DATA SHEET		