

SIDES	BOTTOM
Material: Steel-0.0625"-G60 Galvanized	

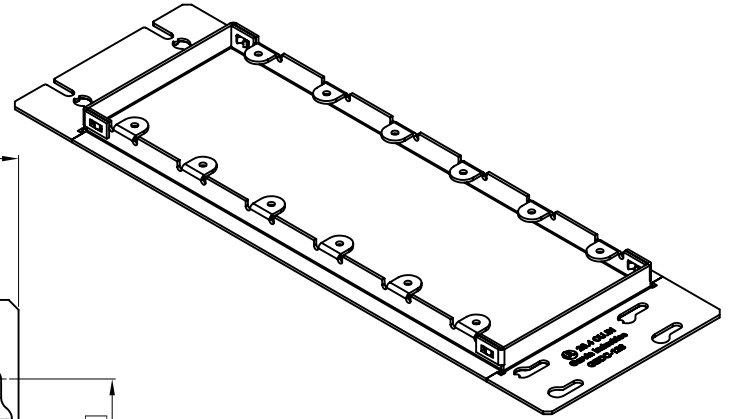
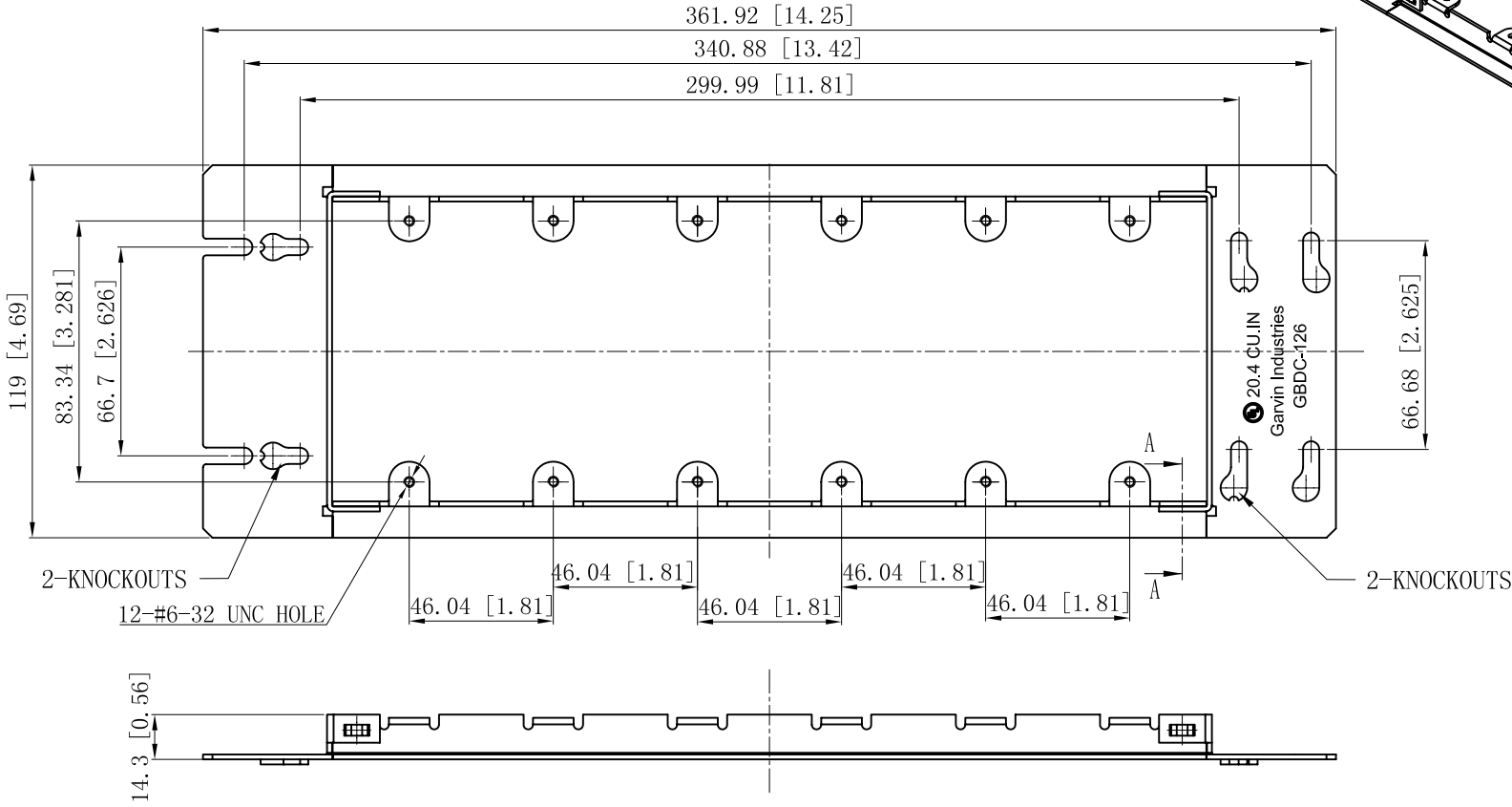

CUTAWAY VIEW A-A

This data sheet is for reference only .GARVIN INDUSTRIES reserves the right to make changes to the design without prior notice.

DESCRIPTION
TRADE REFERENCE TERMS

STANDARD PACKING
5 PCS

GARVIN INDUSTRIES		
TITLE 1/2"RAISED MULTI-GANG DEVICE COVERS		
SIZE A4	DWG NO. GBDC-126	REV A
DATA SHEET		