

SIDES	BOTTOM
Material: Steel-0.0625"-G60 Galvanized	

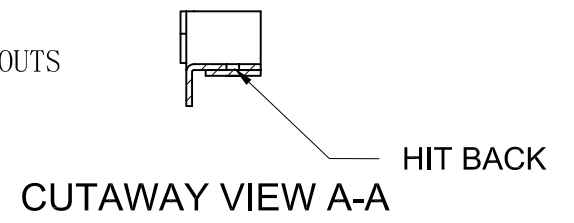
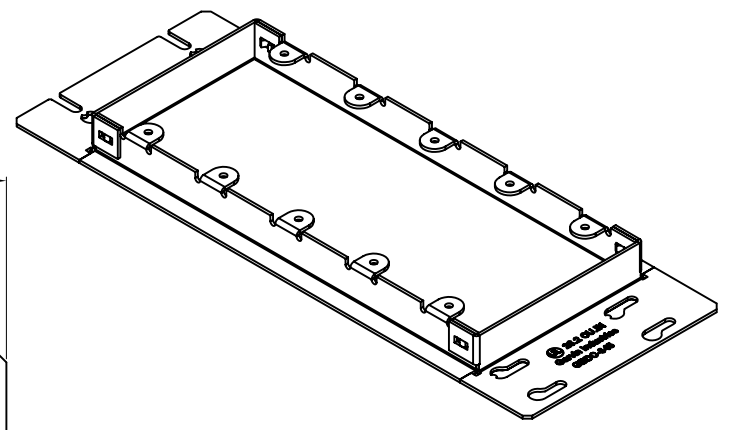
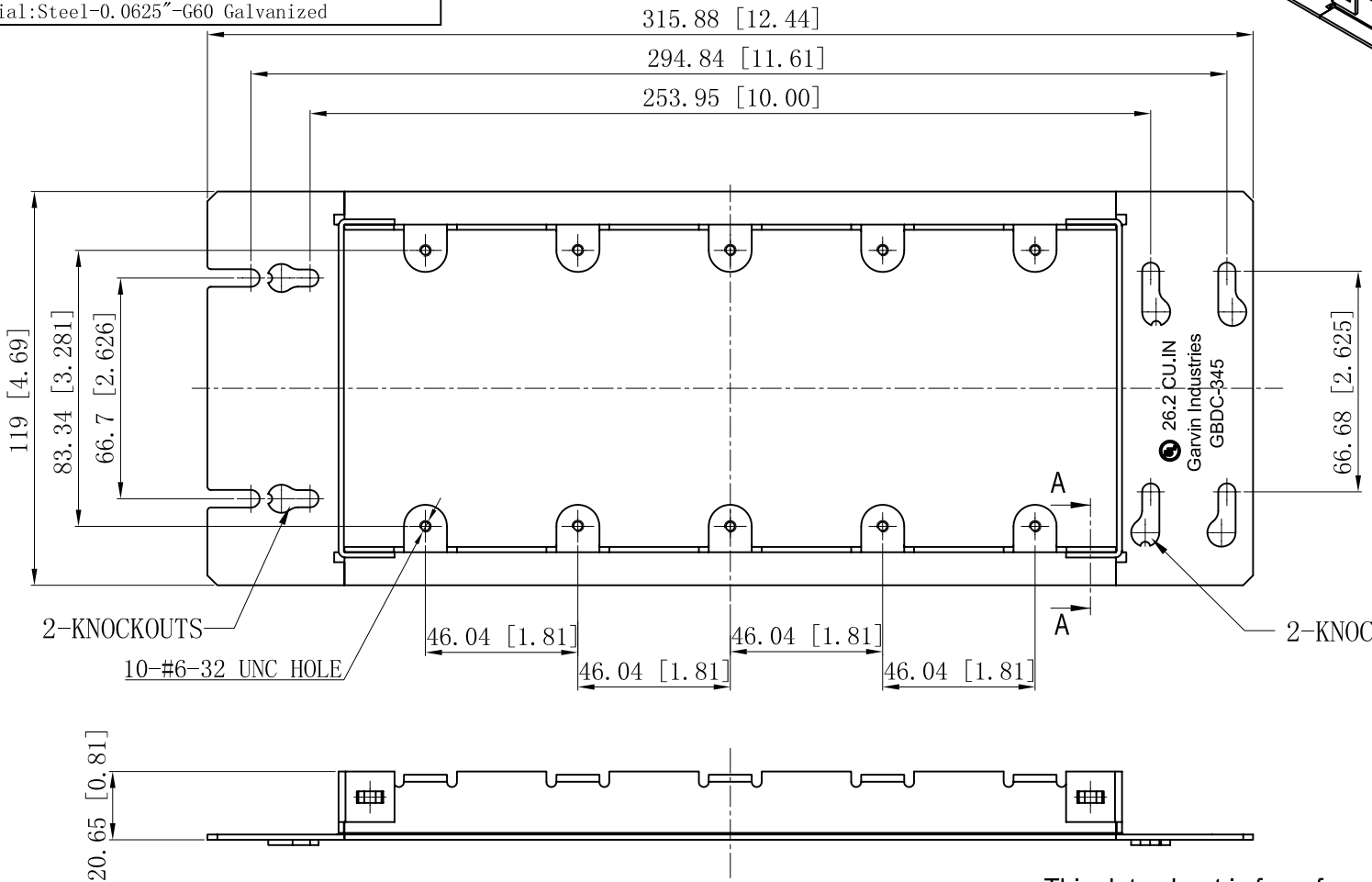

This data sheet is for reference only .GARVIN INDUSTRIES reserves the right to make changes to the design without prior notice.

DESCRIPTION
TRADE REFERENCE TERMS

STANDARD PACKING
10 PCS

GARVIN INDUSTRIES		
TITLE 3/4"RAISED MULTI-GANG DEVICE COVERS		
SIZE A4	DWG NO. GBDC-345	REV A
DATA SHEET		